

# Produktreihe IV68

Holzfenstersysteme, Rahmenstärke 68mm

**Portale**

# Zeichnungsübersicht

<u>Zeichnungsnummer</u>	<u>Beschreibung</u>
01-IV68-SC/13A 01-IV68-SC/13B	<b>Hebe-Schiebe; Schemataübersicht</b> Hebe-Schiebe; Schema A; Vertikalschnitt Hebe-Schiebe; Schema A; Horizontalschnitt
01-IV68-GC/14A/B 01-IV68-GC/14C/D	<b>Parallel-Schiebe-Kipp; Schemataübersicht</b> PSK; Schema A mit FIB PSK; Schema A mit eingeschraubtem Flügel
01-IV68-GC/15A	<b>Faltschiebe; Schemataübersicht</b> Faltschiebe (Sohlbank/Schwelle; Vertikalschnitt)

# Schemata-Übersicht

## Hebe-Schiebe-Portale

**Schema A**

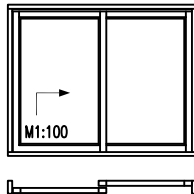

**Schema C**

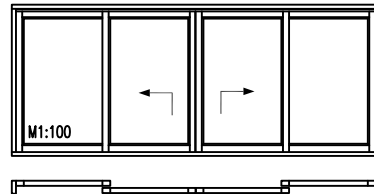

**Schema D**

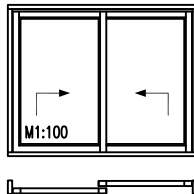

**Schema F**

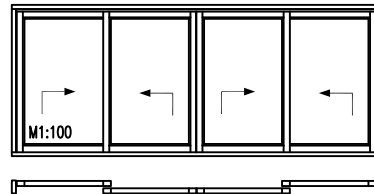

**Schema G**

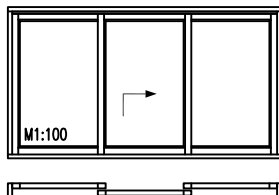

**Schema E**

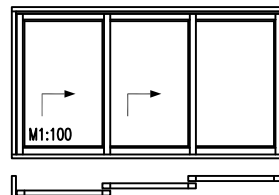

**Schema H**

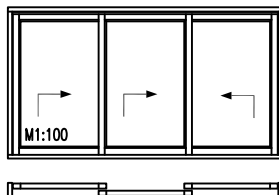

**Schema L**

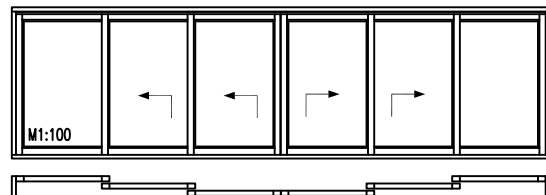

**Schema K**

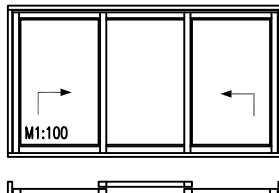

# Holzfenster IV68 - ClassicLine

## Hebe-Schiebe-Anlage

Schemata A, G, C, K

Glasstärken von 18mm bis 36mm

Vertikalschnitte A-A, C-C, E-E

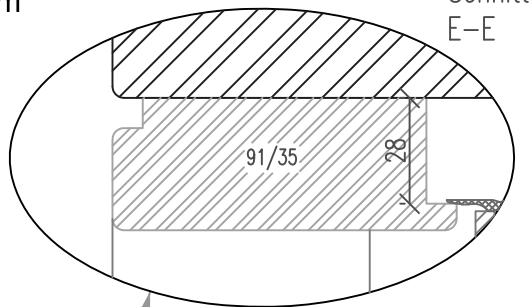
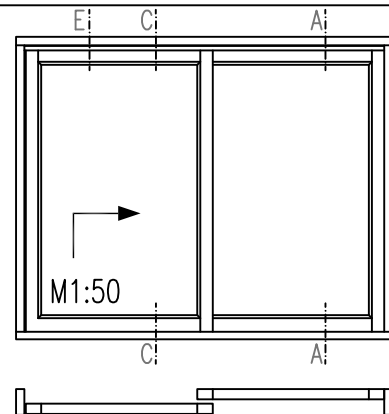

Schnitt E-E

# M1:2

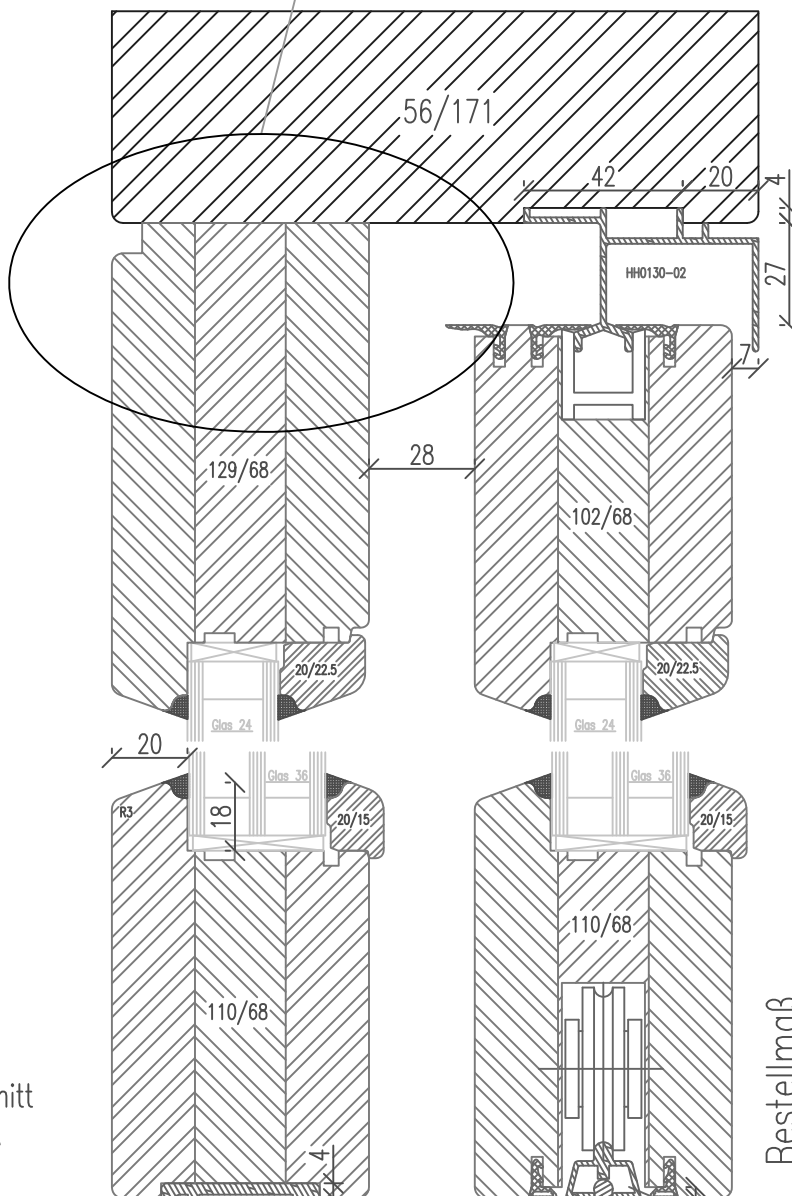

Variante Rustikal

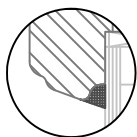

Variante Softline

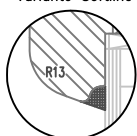

Glasleiste profiliert für Glasstärken 24mm bis 34mm

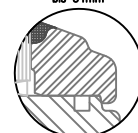

Schnitt C-C

Schnitt A-A

Bestellmaß

optional ohne Aufsatzlaufschiene (Behindertengerecht)

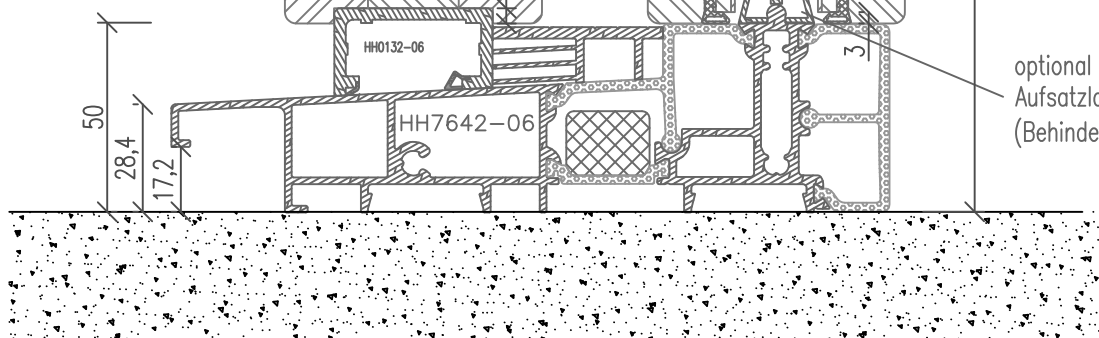

# Holzfenster IV68 - ClassicLine

## Hebe-Schiebe-Anlage

Schema A

Glasstärken von 18mm bis 36mm

Horizontalschnitt A-A

Variante Softline

Variante Rustikal

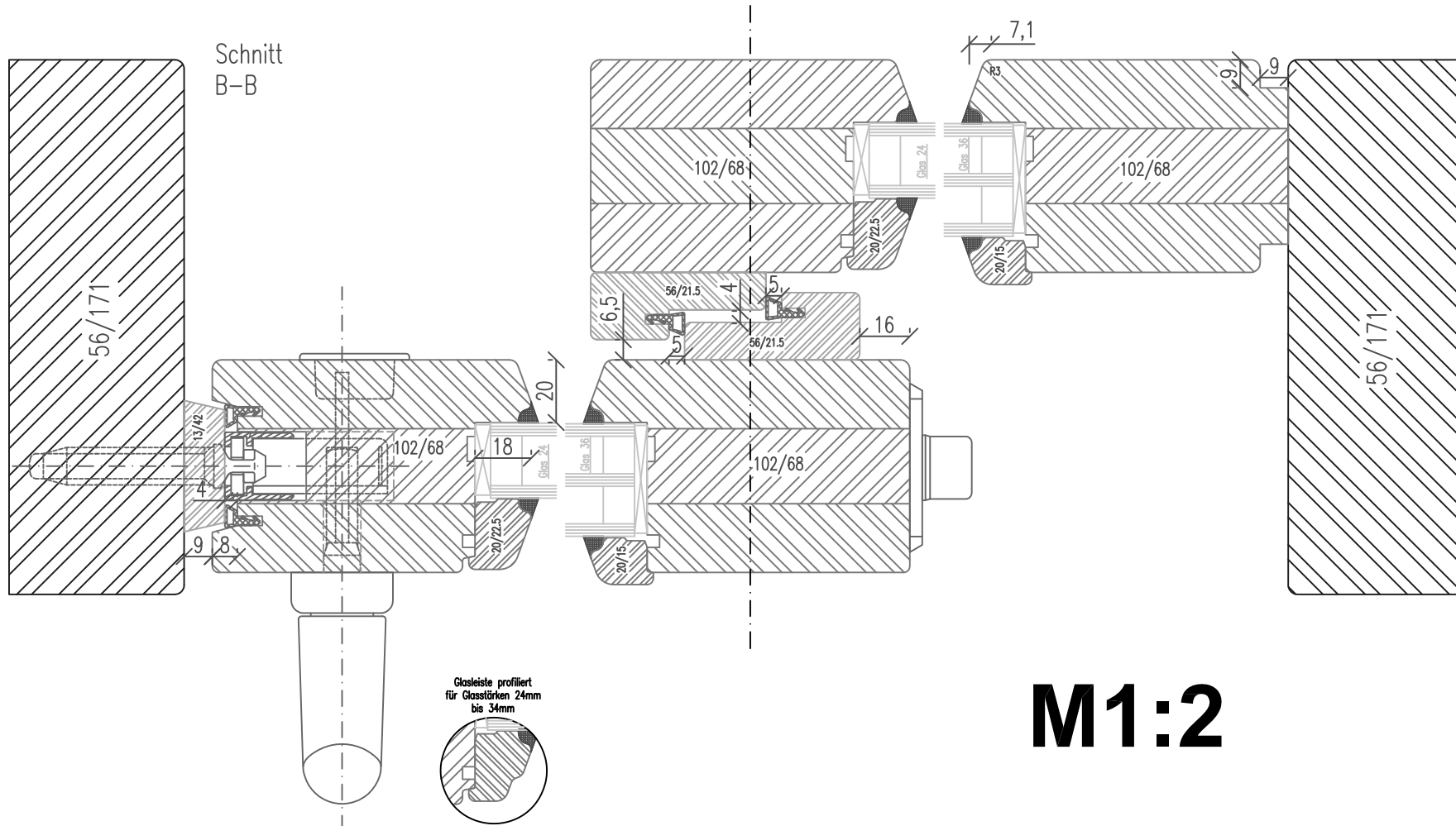
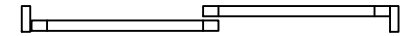
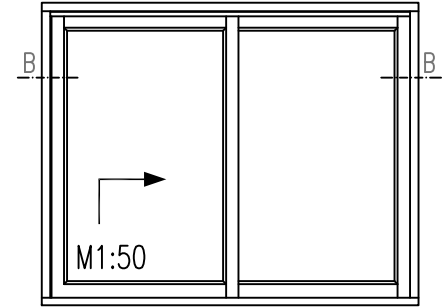
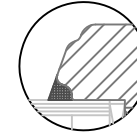
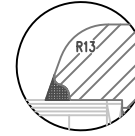

**M1:2**

01-IV68-SC/13B

Zeichnung ohne Gewähr; Änderungen vorbehalten

# Schemata-Übersicht

## Parallel-Schiebe-Kipp Portale

### Variante mit eingeschraubtem Flügel

Schema K

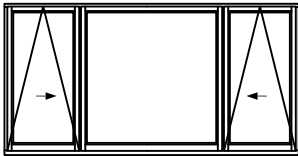

Schema C

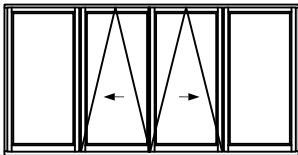

Schema G

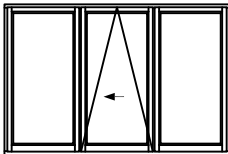

Schema A

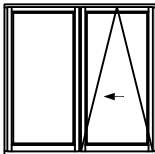

### Variante mit FIB

Schema K

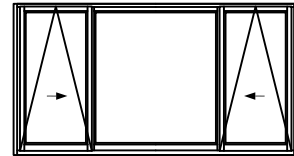

Schema C

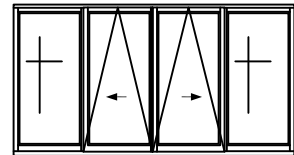

Schema G

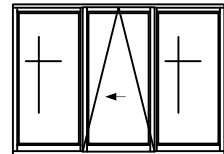

Schema A

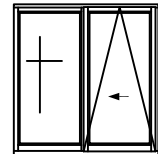

Alle Schemata können auch  
spiegelbildlich ausgeführt  
werden

# Holzfenster IV68 - ClassicLine

## Parallel-Schiebe-Kippanlage

Schema A

Seitenteil mit FIB

Regenschiene aufliegend

Getriebeutmitte 13.15mm

Glasstärken 18mm bis 36mm

Variante Softline

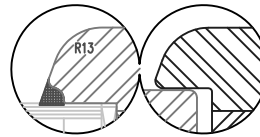

Variante Rustikal

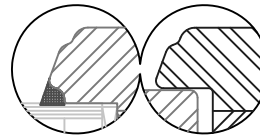

Vertikalschnitt A-A  
Horizontalschnitt B-B

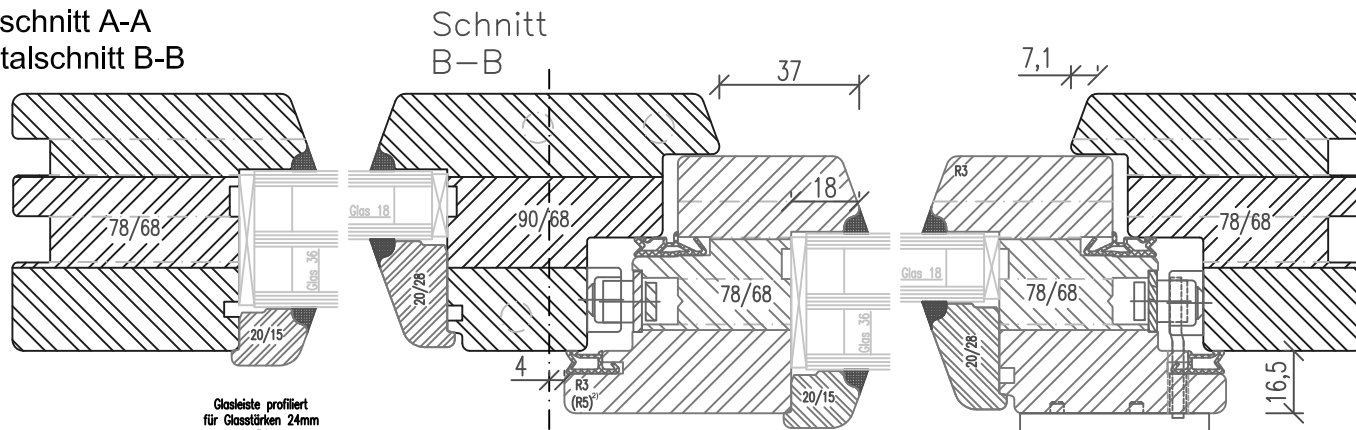

Glasleiste profiliert für Glasstärken 24mm bis 34mm

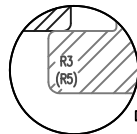
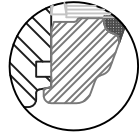

optional ohne Dichtung am Überschlag<sup>2)</sup>

ohne Regenschiene  
ohne Regenschiene

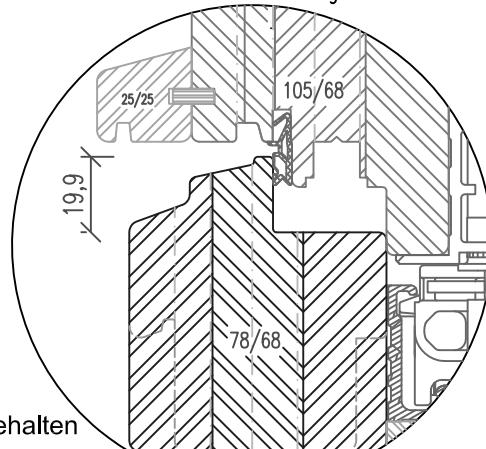

Regenschiene vorgesetzt

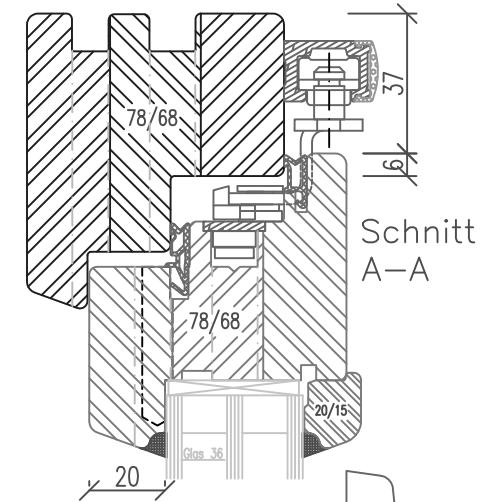
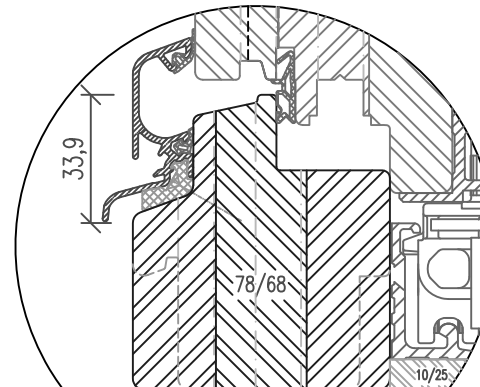

Schnitt A-A

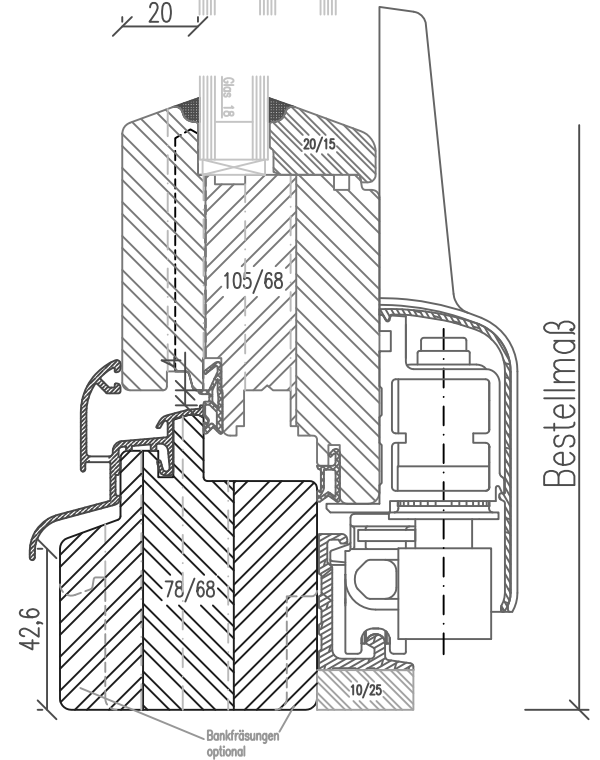

Bestellmaß

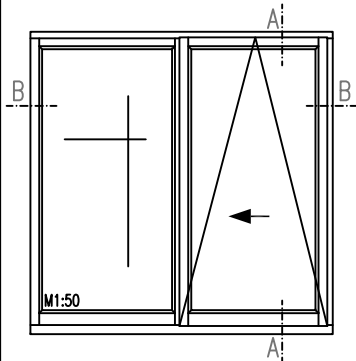

2) SoftLine mit Rundungsradius R5

Zeichnung ohne Gewähr; Änderungen vorbehalten

# M1:2

01-IV68-GC/14A/B

# Holzfenster IV68 - ClassicLine

## Parallel-Schiebe-Kippanlage

Schema A

Seitenteil mit festem Flügel

Regenschiene aufliegend

Getriebeutmitte 13.15mm

Glasstärken 18mm bis 36mm

Variante Softline

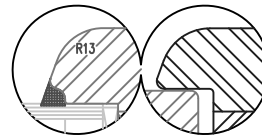

Variante Rustikal

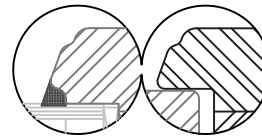

Vertikalschnitt A-A  
Horizontalschnitt B-B

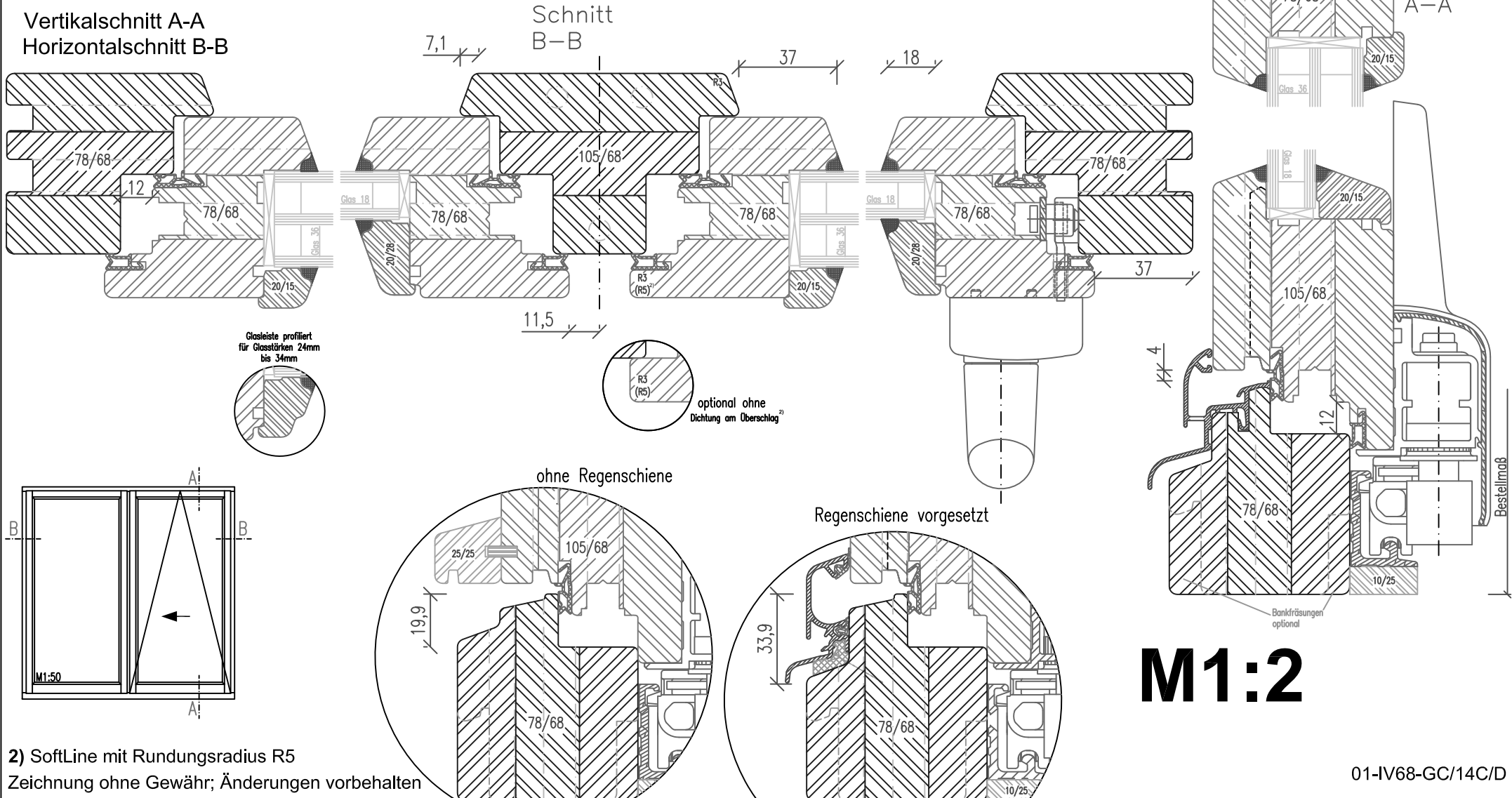

# M1:2

2) SoftLine mit Rundungsradius R5  
Zeichnung ohne Gewähr; Änderungen vorbehalten

01-IV68-GC/14C/D



# Schemata-Übersicht

## Falt-Schiebe-Portale

Schema 220

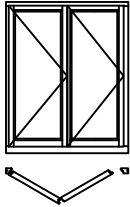

Alle Schemata können auch  
spiegelbildlich ausgeführt  
werden

Schema 330

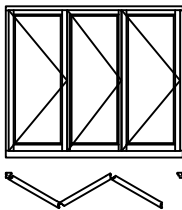

Schema 321

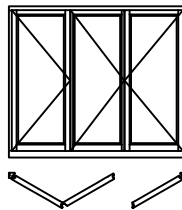

Schema 440

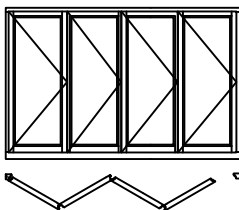

Schema 431

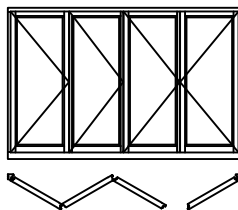

Schema 550

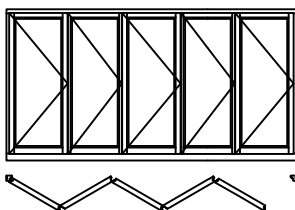

Schema 541

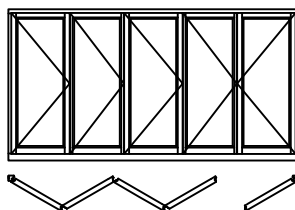

Schema 532

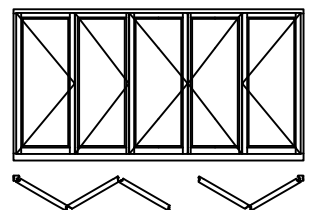

Schema 660

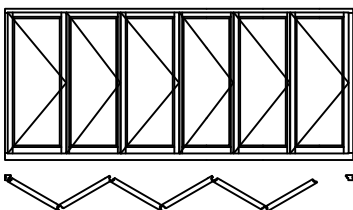

Schema 651

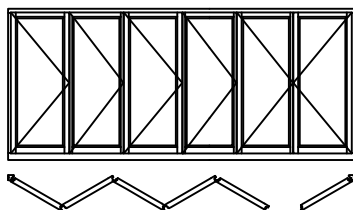

Schema 633

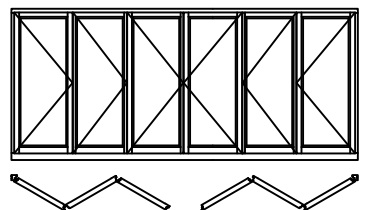

Schema 770

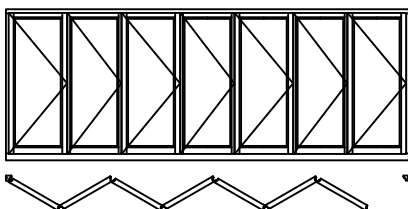

Schema 761

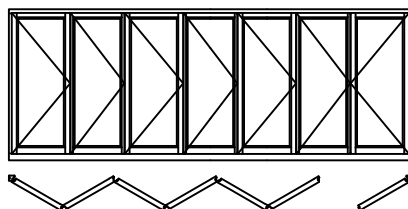

Schema 743

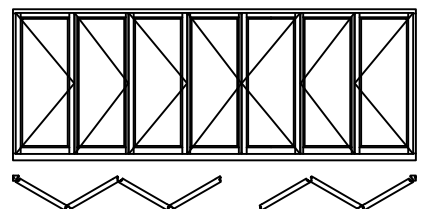

# Holzfenster IV68 - ClassicLine Falt-Schiebe-Portal

mit Sohlbank oder Schwelle  
Regenschiene aufliegend  
Getriebeutmitte 13.15mm  
Glasstärken 18mm bis 36mm

Vertikalschnitt A-A

Variante Softline Variante Rustikal

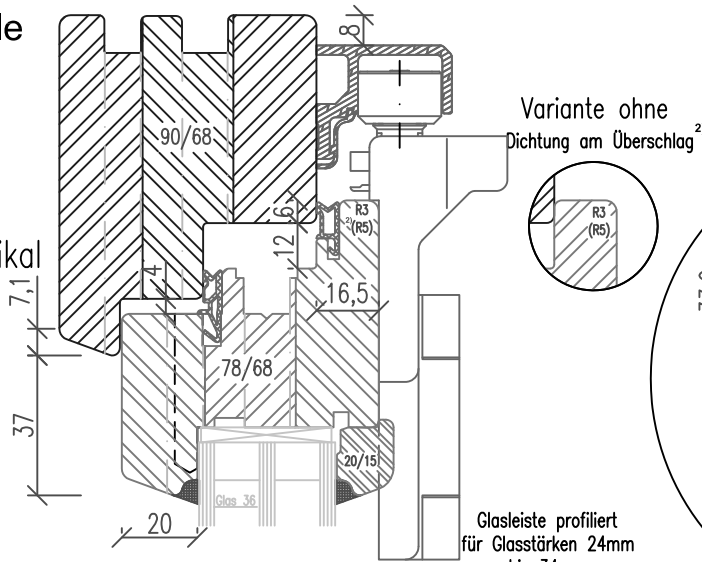
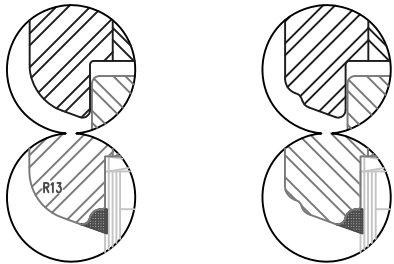

Regenschiene vorgesetzt

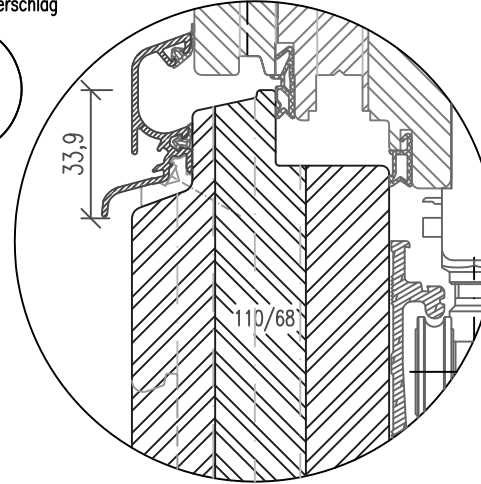

Glasleiste profiliert für Glasstärken 24mm bis 34mm

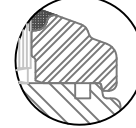

ohne Regenschiene

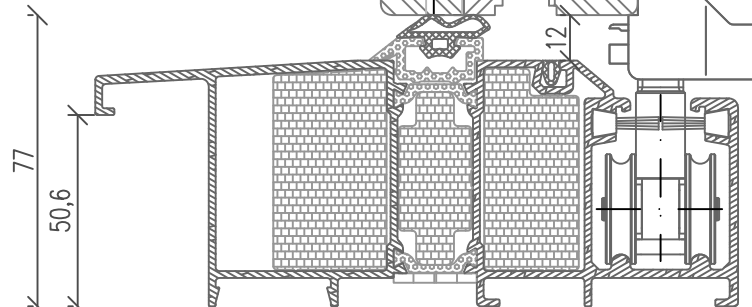
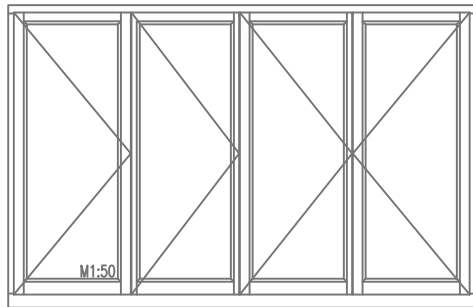
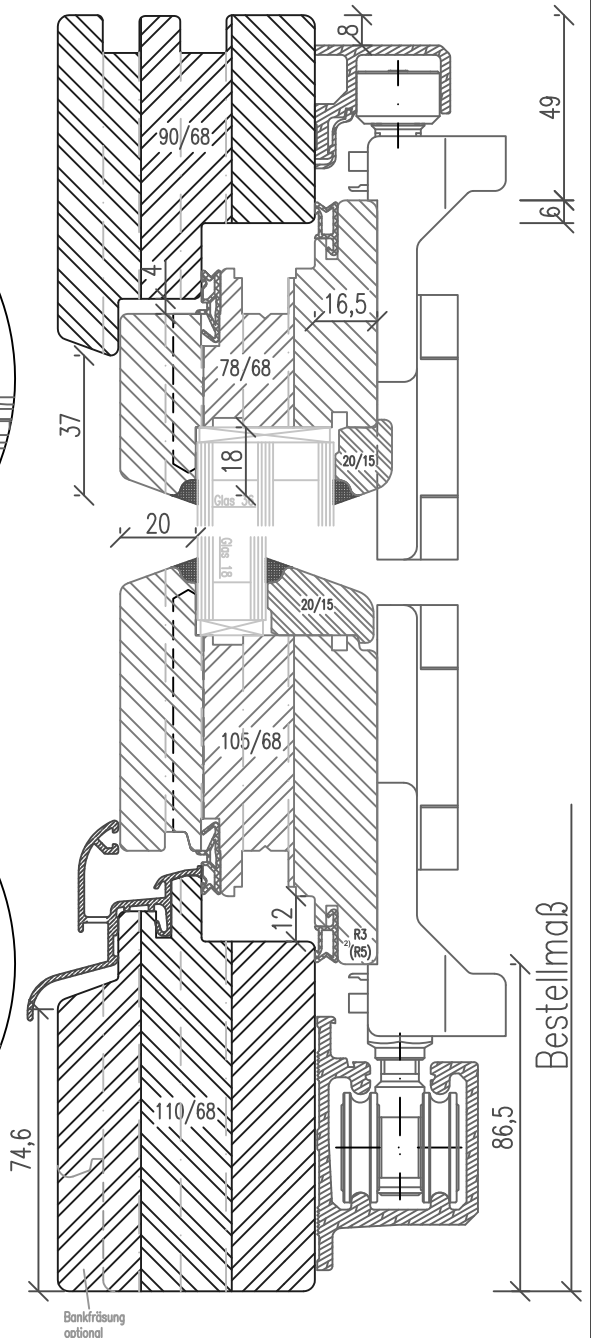
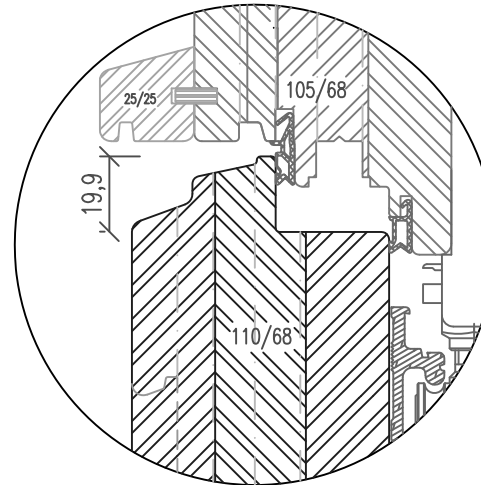

2) SoftLine mit Rundungsradius R5

Zeichnung ohne Gewähr; Änderungen vorbehalten

# M1:2

01-IV68-GC/15A